

PROHLÁŠENÍ O VLASTNOSTECHDoP č. **MKT-531** - cz

- ✧ **Jedinečný identifikační kód typu výrobku:** **Vstřikovací systém VME**
- ✧ **Zamýšlené/zamýšlená použití:** Následné zapuštěné přípojky s vstřikovací systém s VME, viz příloha/Annex B
- ✧ **Výrobce:** MKT Metall-Kunststoff-Technik GmbH & Co.KG
Auf dem Immel 2
67685 Weilerbach
- ✧ **Systém/systémy POSV:** 1
- ✧ **Evropský dokument pro posuzování:** **EAD 330087-00-0601**
Evropské technické posouzení: **ETA-07/0299, 09.11.2017**
Subjekt pro technické posuzování: DIBt, Berlin
Oznámený subjekt/oznámené subjekty: NB 1343 – MPA, Darmstadt

✧ **Deklarovaná vlastnost / Deklarované vlastnosti:**

Základní charakteristiky	Vlastnosti
Mechanická odolnost a stabilita (BWR1)	
Zvýšení faktoru α_{lb} , pouto stres f_{bd}	Příloha /Annex C1
Požární bezpečnost (BWR2)	
Chování při požáru	Třída A1
Požární odolnost	Příloha /Annex C2 – C3

Vlastnosti výše uvedeného výrobku jsou ve shodě se souborem deklarováných vlastností. Toto prohlášení o vlastnostech se v souladu s nařízením (EU) č. 305/2011 vydává na výhradní odpovědnost výrobce uvedeného výše.

Podepsáno za výrobce a jeho jménem:



Stefan Weustenhagen
(Výkonný ředitel)
Weilerbach, 09.11.2017

p.p.

Dipl.-Ing. Detlef Bigalke
(Vedoucí vývoje produktu)

Originál tohoto prohlášení byl napsán v němčině. V případě odchylek v překladu platí německá verze.

Specifications of intended use

Anchorage subject to:

- Static or quasi static action
- Fire exposure

Base material:

- Reinforced or unreinforced normal weight concrete acc. to EN 206-1:2000.
- Strength classes C12/15 to C50/60 acc. to EN 206-1:2000.
- Maximum chloride concrete of 0,40 % (CL 0,40) related to the cement content acc. to EN 206-1:2000.
- Non-carbonated concrete.

Note: In case of a carbonated surface of the existing concrete structure the carbonated layer shall be removed in the area of the post-installed rebar connection with a diameter of $\varnothing + 60$ mm prior to the installation of the new rebar.
The depth of concrete to be removed shall correspond to at least the minimum concrete cover in accordance with EN 1992-1-1:2004+AC:2010.

The foregoing may be neglected if building components are new and not carbonated and if building components are in dry conditions.

Temperature range:

- - 40 °C to +80 °C (max. long term temperature +80 °C and max. short term temperature +50 °C)

Use conditions (Environmental conditions):

- Structures subject to dry internal conditions (zinc plated steel, stainless steel or high corrosion resistant steel).
- Structures subject to external atmospheric exposure including industrial and marine environment or exposure to permanently damp internal condition, if no particular aggressive conditions exist (stainless steel or high corrosion resistant steel).
- Structures subject to external atmospheric exposure and to permanently damp internal condition, if other particular aggressive conditions (high corrosion resistant steel).

Note: Particular aggressive conditions are e.g. permanent, alternating immersion in seawater or the splash zone of seawater, chloride atmosphere of indoor pools or atmosphere with extreme chemical pollution (e.g. in desulphurization plants or road tunnels where de-icing materials are used).

Design:

- Verifiable calculation notes and drawings are prepared taking account of the loads to be anchored. The position of the anchor is indicated on the design drawings (e.g. position of the anchor relative to reinforcement or to supports, etc.).
- Anchorages are designed under the responsibility of an engineer experienced in anchorages and concrete work.
- Anchorages are designed in accordance with EN 1992-1-1 and Annex B2.
- The actual position of the reinforcement in the existing structure shall be determined on the basis of the construction documentation and taken into account when designing.

Installation:

- Dry or wet concrete
- The rebar connection must not be placed in water-filled boreholes.
- Overhead installation admissible
- Check the position of the existing rebars (if the position of existing rebars is not known, it shall be determined using a rebar detector suitable for this purpose as well as on the basis of the construction documentation and then marked on the building component for the overlap joint)
- Hole drilling by hammer drill, vacuum drill, compressed air drill or diamond drill mode.
- While curing of the injection mortar, the temperature of the member shall not fall below +5°C and must not exceed +40°C.
- The installation of post-installed rebar or tension anchor ZA shall be done only by suitable trained installer and under supervision on site; the conditions under which an installer may be considered as suitable trained and the conditions for supervision on site are up to the member states in which the installation is done.

Injection System VME

Intended use
Specifications of intended use

Annex B1

General construction rules for post-installed reinforcing bars and tension anchor ZA

- Bond strength f_{bd} acc. to EN 1992-1-1 may be applied.
- The shear transfer between old and new concrete shall be designed acc. to EN 1992-1-1.
- If the clear distance of overlapping bars is greater than $4\varnothing$, the lap length must be increased by a length equal to the clear space where it exceeds $4\varnothing$.
- The minimum concrete cover acc. to EN 1992-1-1 shall be kept.

Figure B1: Post-installed rebars

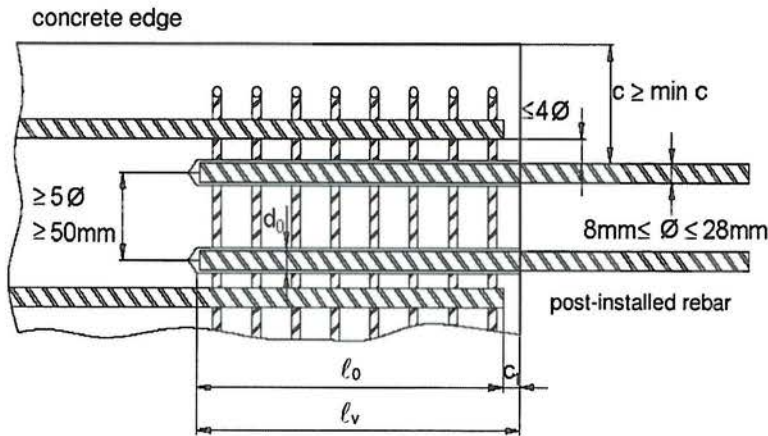

- c concrete cover of post-installed reinforcement
- c_1 concrete cover at front end of cast-in-place rebar
- $\text{min } c$ minimum concrete cover according Table B1
- \varnothing diameter of post-installed rebar
- l_0 lap length acc. to EN 1992-1-1
- l_v embedment depth $l_v \geq l_0 + c_1$
- d_0 nominal drill bit diameter according to Annex B4, Table B4

Figure B2: Tension anchor ZA

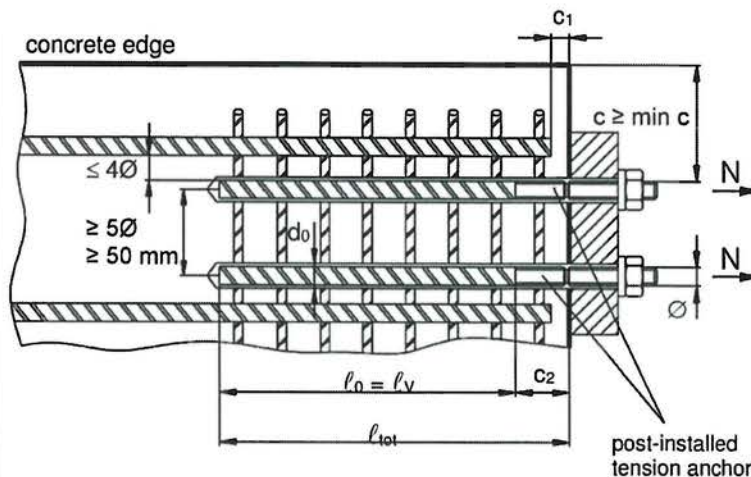

- c concrete cover of post-installed tension anchor ZA
- c_1 concrete cover at front side of cast-in-place rebar
- $\text{min } c$ minimum concrete cover acc. to Table B1
- c_2 length of bonded thread ($c_2 > c_1$; see Table B1)
- \varnothing diameter of tension anchor
- l_0 lap length acc. to EN 1992-1-1
- l_{tot} embedment depth $l_{tot} \geq l_0 + c_2$
- d_0 nominal drill bit diameter according Annex B4, Table B4

Injection System VME

Intended use
General construction rules

Annex B2

Table B1: Minimum concrete cover min c¹⁾ of post-installed rebars and tension anchor ZA depending on drilling method and drilling tolerances

Drilling method	Rebar diameter	min c (without drilling aid device)	min c (with drilling aid device)
Hammer drilling, vacuum drilling, diamond core drilling	< 25 mm	30 mm + 0,06 l _v ≥ 2 Ø	30 mm + 0,02 l _v ≥ 2 Ø
	≥ 25 mm	40 mm + 0,06 l _v ≥ 2 Ø	40 mm + 0,02 l _v ≥ 2 Ø
Compressed air drilling	< 25 mm	50 mm + 0,08 l _v	50 mm + 0,02 l _v
	≥ 25 mm	60 mm + 0,08 l _v	60 mm + 0,02 l _v

¹⁾ Minimum concrete cover acc. to EN 1992-1-1 must be observed.

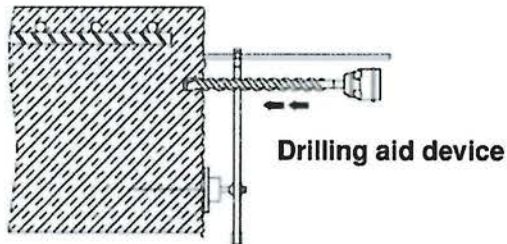

Table B2: Dimensions and installation parameters of tension anchor ZA

Anchor size			M12	M16	M20	M24	
Rebar diameter	Ø	[mm]	12	16	20	25	
Cross-section area (threaded part)	A _s	[mm ²]	84	157	245	353	
Width across nut flats	SW	[mm]	19	24	30	36	
Effective embedment depth	l _v	[mm]	$l_v = l_{tot} - C_2$				
Length of bonded thread	steel, zinc plated	C ₂	[mm]	≥ 20	≥ 20	≥ 20	≥ 20
	A4 / HCR			≥ 100	≥ 100	≥ 100	≥ 100
Maximum installation torque	T _{inst}	[Nm]	50	100	150	150	

Table B3: Maximum embedment depth

Rebar / Tension Anchor ZA	Mortar temperature	Max. embedment depth l _{v, max}
Ø 8 to 12 mm	+5°C to +19°C	130 cm
	≥20°C	200 cm
Ø 14 to 28 mm	+5°C to +19°C	200 cm
	≥20°C	280 cm

Injection System VME

Intended use

Minimum concrete cover, installation parameters, maximum embedment depth

Annex B3

Table B4: Cleaning and installation tools

Rebar \varnothing	Tension anchor ZA	Drill bit diameter d_0	Blow out nozzle \varnothing	Brush \varnothing (diamond drilling)	Extension pipe (outer \varnothing)	Retaining washer \varnothing
[mm]	[-]	[mm]	[mm]	[mm]	[mm]	[mm]
8	-	12	10	13,0	10	10
10	-	14	10	15,5		13
12	M12	16	14	17,5		15
14	-	18	14	19,5	16	17
16	M16	20	17	22		19
20	M20	25	17	27		24
24	-	30	27	32		29
25	M24	32	27	34		31
26	-	32	27	34		31
28	-	35	27	37		34

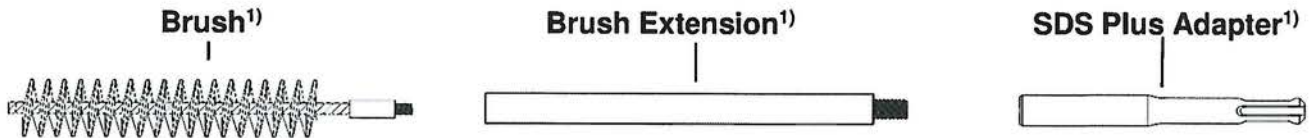
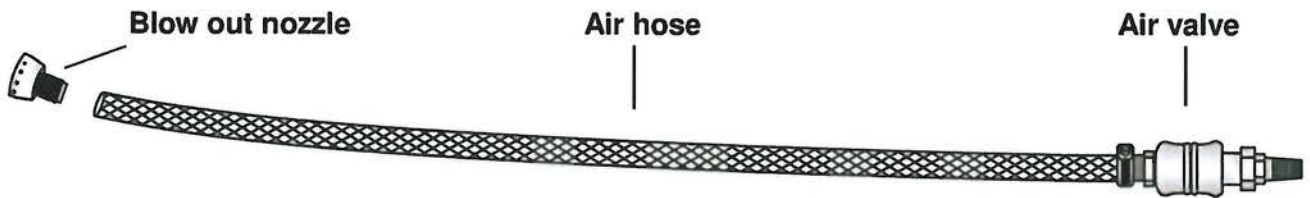

1) Additional cleaning tools for diamond core drilling

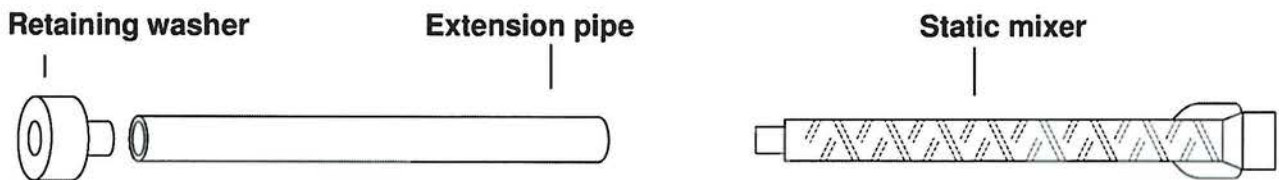

Injection System VME

Intended use
Cleaning and Installation tools

Annex B4

Table B5: Working time and curing time

Temperature in the bore hole	Working time	Minimum curing time
+5°C to +9°C	60 min	72 h
+10°C to +19°C	45 min	36 h
+20°C to +29°C	30 min	10 h
+30°C to +39°C	20 min	6 h
+40°C	12 min	4 h

Note: A mortar temperature > + 20 ° C reduces the press out forces and accelerates the injection of the mortar. When using the adhesive in wet concrete the curing times have to be doubled.

Installation instructions

Preparation:

- a. Remove carbonated concrete and roughen concrete surface prior to installation of post-installed rebars.
- b. Determine position and diameter of existing reinforcement. Only the admissible force of the existing reinforcement can be transmitted into the post-installed rebar connection
- c. The drilling aid device must be adjusted towards the existing reinforcement
- d. The concreting joints must be roughened to at least such an extent that the aggregates protrude

Making and cleaning of hammer drilled, vacuum drilled and compressed air drilled holes

Bore hole drilling

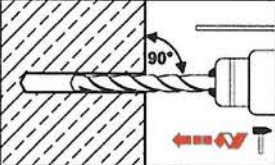
1		<p>Select drill bit diameter according to Table B4. Build drill hole by hammer drilling, vacuum drilling or compressed air drilling. In case of aborted holes, the bore holes must be filled with mortar.</p>
---	---	---

Cleaning

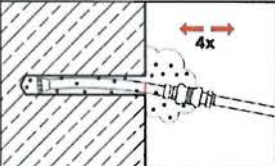
2a		<p>Assemble provided blow out nozzles, air hoses and air valve and connect to compressed air (≥ 6 bar). Place marking on the air hose at a distance from the end equal to the drill hole depth. Open compressed air valve and blow out 4x from top to bottom and reverse. The air hose marking has to get below the concrete surface in order to ensure cleaning to the very bottom of the hole.</p>
----	---	---

Injection System VME

Intended use

Working and curing time, Installation instructions – Preparation;
 Making and cleaning of hammer drilled, vacuum drilled and compressed air drilled holes

Annex B5

Installation instruction (continuation)

Marking and cleaning of diamond core drilled holes

Bore hole drilling

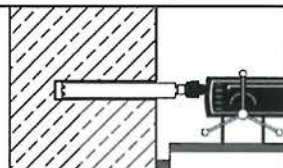
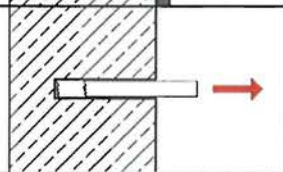
1a		Drill hole by using a diamond drill with diamond drill bit.
1b		Remove drill core at least up to the nominal hole depth and check drill hole depth.

Cleaning

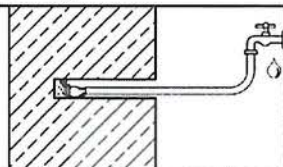
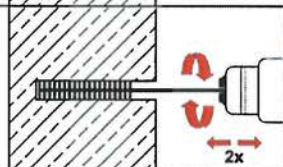
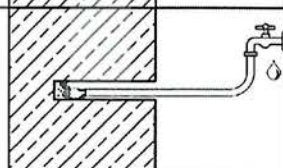
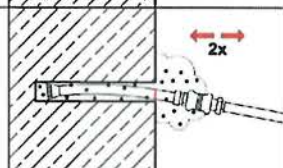
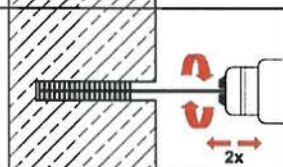
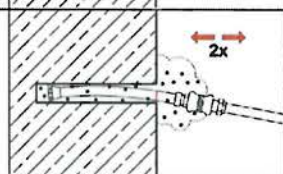
2a		Flush drill hole with water, starting from the bottom, until clear water gets out of the drill hole.
2b		Choose brush suitable to the hole. Brush bore hole 2x using a cordless screwdriver or a drilling machine. Use brush extension for deep holes.
2c		Flush drill hole again with water, starting from the bottom, until clear water gets out of the drill hole.
2d		Assemble provided blow out nozzles, air hoses and air valve and connect to compressed air (≥ 6 bar). Place marking on the air hose at a distance from the end equal to the drill hole depth. Open compressed air valve and blow out 2x from top to bottom and reverse. The air hose marking has to get below the concrete surface in order to ensure cleaning to the very bottom of the hole.
2e		Brush the hole again 2x (according to step 2b).
2f		Blow out again 2x (according to step 2d).

Injection System VME

Intended use
 Installation instructions
 Making and cleaning of diamond core drilled holes

Annex B6

Installation Instruction (continuation)

Injection into bore hole

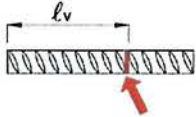
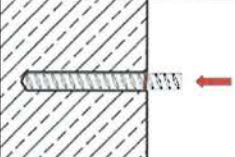
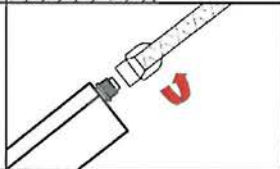
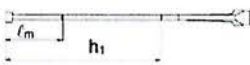
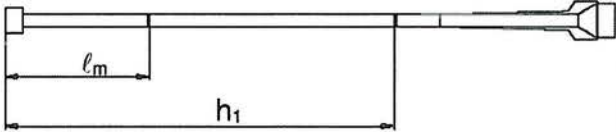
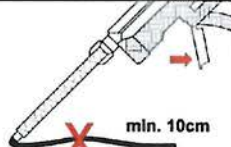
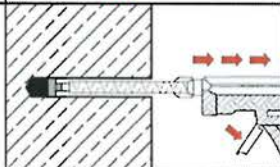
3a		Mark the position of the embedment depth l_v on the rebar.
3b		Check bore hole depth by inserting rebar or tension anchor up to the marking in the empty hole.
4		Prepare cartridge with static mixer, extension pipe and retaining washer. Extension pipe must correspond the hole depth.
5		<p>Attach marking length l_m on extension pipe for injection of adhesive:</p> <p>a) Estimation: $l_m = 1/3 * h_1 \quad [\text{mm}]$</p> <p>b) Precise formula for optimum volume (compressed air drilling): $l_m = h_1 * (1,2 * \frac{\varnothing^2}{d_0^2} - 0,2) \quad [\text{mm}]$</p> <p>$l_m$ Length from the end of the retaining washer to the mark on the mixer extension h_1 drill hole depth = embedment depth (l_v resp. l_{tot}) \varnothing rebar diameter d_0 nominal drill bit diameter</p> <p>When using hammer drill or diamond core, the length l_m may be multiplied by 1,10.</p> 
6		Prior to applying, discard at least a 10 cm line of mortar (forerun) until the mortar shows a consistent colour. Never use this mortar!
7		Fill the hole starting from the bottom with injection mortar VME without air bubbles. Inject until the marking l_m on the extension pipe can be seen.

Injection System VME

Intended use
 Installation instructions
 Injection into bore hole

Annex B7

Installation Instruction (continuation)

Installation of rebar or tension anchor

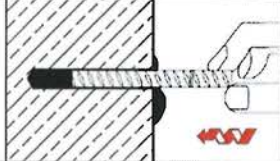
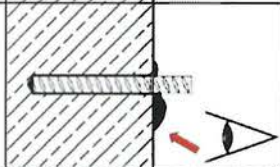
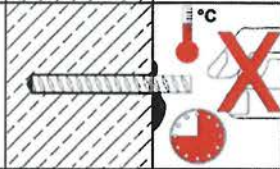
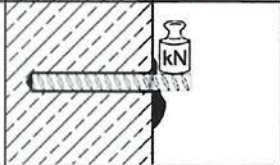
7		<p>Push the rebar or tension anchor into the hole while turning slightly until the embedment depth is reached.</p> <p>The bar should be free of dirt, grease, oil or other foreign material.</p>
8		<p>Excessive adhesive must exceed out of the drill hole. Otherwise pull out rebar, drill out hole after curing of the adhesive and start again from No. 2.</p>
9		<p>Keep curing time according to Annex B5, Table B5. Do not move or load the rod during curing time.</p>
10		<p>After curing, the rod can be loaded.</p>

Injection System VME

Intended use
Installation instructions
Installation of rebar or tension anchor

Annex B8

Minimum anchorage length and minimum lap length

The minimum anchorage length $\ell_{b,min}$ and the minimum lap length $\ell_{0,min}$ according to EN 1992-1-1 ($\ell_{b,min}$ acc. to Eq. 8.6 and Eq. 8.7 and $\ell_{0,min}$ acc. to Eq. 8.11) shall be multiplied by the amplification factor α_{lb} acc. to Table C1.

Table C1: Amplification factor α_{lb}

Concrete strength class	Drilling method	Amplification factor α_{lb}
C12/15 to C50/60	Hammer drilling, vacuum drilling or compressed air drilling	1,0
	Diamond coring	1,5

Table C2: Design values of the ultimate bond resistance f_{bd} ¹⁾

Rebar Tension Anchor ZA		Concrete strength class								
		C12/15	C16/20	C20/25	C25/30	C30/37	C35/45	C40/50	C45/55	C50/60
Design value of bond resistance f_{bd}										
Hammer drilling, vacuum drilling or compressed air drilling	[N/mm ²]	1,6	2,0	2,3	2,7	3,0	3,4	3,7	4,0	4,3
Diamond coring	[N/mm ²]	1,6	2,0	2,3	2,7	3,0	3,0	3,4	3,7	3,7

¹⁾ With $\eta_1=1,0$ acc. to EN 1992-1-1 for good bond conditions (for all other bond conditions multiply the values by 0,7)

Injection System VME

Performances
Amplification factor
Design values of ultimate bond resistance f_{bd}

Annex C1

Design value of ultimate bond stress $f_{bd,fi}$ under fire exposure for concrete classes C12/15 to C50/60 (all drilling methods):

The design value of ultimate bond stress $f_{bd,fi}$ under fire exposure will be calculated by the following equation:

$$f_{bd,fi} = k_{b,fi}(\theta) \cdot f_{bd} \cdot \gamma_c / \gamma_{M,fi}$$

with: $\theta \leq 270^\circ\text{C}$ $k_{b,fi}(\theta) = 9221,2 \cdot \theta^{-1,747} / (f_{bd} \cdot 4,3) \leq 1,0$

$\theta > 270^\circ\text{C}$ $k_{b,fi}(\theta) = 0$

$f_{bd,fi}$ design value of ultimate bond stress in case of fire in N/mm^2

θ Temperature in $^\circ\text{C}$ in the mortar layer

$k_{b,fi}(\theta)$ Reduction factor under fire exposure

f_{bd} Design value of the ultimate bond stress in N/mm^2 in cold condition according to Table C2 considering concrete class, rebar diameter, drilling method and the bond conditions according to EN 1992-1-1.

γ_c partial factor acc. to EN 1992-1-1

$\gamma_{M,fi}$ partial factor acc. to EN 1992-1-2

For evidence under fire exposure the anchorage length shall be calculated according to EN 1992-1-1:2004+AC:2010 Equation 8.3 using the temperature-dependent ultimate bond stress $f_{bd,fi}$.

Picture C1: Example graph of reduction factor $k_{b,fi}(\theta)$
Concrete strength class C20/25 for good bond conditions

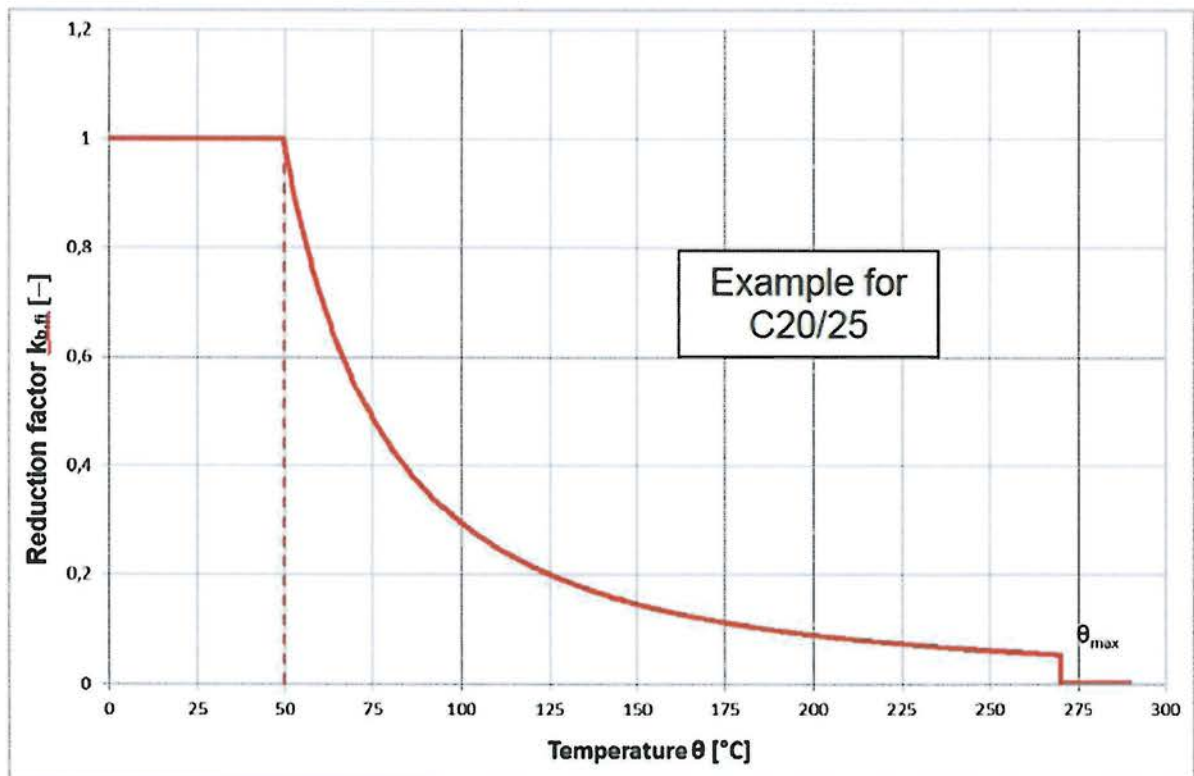

Injection System VME

Performances

Design value of ultimate bond stress $f_{bd,fi}$ under fire exposure

Annex C2

Table C3: Characteristic tension strength in case of fire for tension anchor ZA, concrete strength class C12/15 to C50/60, acc. to Technical Report TR 020

Tension anchor ZA		M12	M16	M20	M24
Steel, zinc plated					
Characteristic tension strength	R30	$\sigma_{Rk,s,fi}$ [N/mm ²]	20		
	R60		15		
	R90		13		
	R120		10		
Stainless steel A4, HCR					
Characteristic tension strength	R30	$\sigma_{Rk,s,fi}$ [N/mm ²]	30		
	R60		25		
	R90		20		
	R120		16		

Design value of the tension strength $\sigma_{Rd,s,fi}$ under fire exposure for tension anchor ZA

The design value of the steel strength $\sigma_{Rd,s,fi}$ under fire exposure will be calculated by the following equation:

$$\sigma_{Rd,s,fi} = \sigma_{Rk,s,fi} / \gamma_{M,fi}$$

with:

$\sigma_{Rk,s,fi}$ characteristic steel strength acc. to Table C3
 $\gamma_{M,fi}$ partial factor under fire exposure acc. to EN 1992-1-2

Injection System VME

Performances
 Steel strength for tension anchor ZA under fire exposure

Annex C3